



Vespa Super

OPERATION AND MAINTENANCE

scooterhelp.com





Vespa

125 Super

150 Super

OPERATION AND MAINTENANCE

scooterhelp.com



NOTICE

To maintain your Vespa in perfect running order and not to invalidate the guarantee offered by the contract, it is advisable to consult your dealer or Service Station, recognisable by the disc shown here regarding repairs.

Demand exclusively original Piaggio spares.



All PIAGGIO spare parts are produced from the same specific materials, have been subjected to the same machining operation and inspection as the component parts of your machine. This is guarantee for durability, performance and your personal safety.

INDEX

Introduction	Page 4	Maintenance	Page 27
Layout of controls	» 5	Summary of Instruct. for Maintenance »	28
Operating instructions	» 6	Cleaning the vehicle	» 30
Oil to be used for the fuel mixture »	8	Operating instruction: Fault finding »	32
Running - in	» 10	General specification	» 34
Tyre pressure	» 10	Accessories	» 36
Operating and maintenance:		Electrical equipment	» 38
common operations to carry out »	14	Identification data	» 39
		Specific characteristics	» 41





Fig. 1 - Vespa « Super »



INTRODUCTION

The **PIAGGIO CO.** wishes to welcome you into the family of Vespa owners and take this opportunity of thanking you for your preference. We feel sure that this scooter will give you complete satisfaction.

Because of its characteristics (comfort, limited consumption, easy driving, quiet engine, clean lines, etc.) the Vespa has a wide range of uses for practical operation and pleasure trips. Long journeys on the Vespa will not fatigue you and you will quickly appreciate its first class performance.

This booklet, with its **simple instructions** on operation and maintenance will furnish you all the information necessary for gaining a complete working knowledge of your vehicle.

N. B. - This booklet illustrates the models of **Vespa «Super», provided with 150 cc. engine and 125 cc. engine.** The operation and maintenance instructions are valid for both models; the specific characteristics of each model are reported at page 41.

scooterhelp.com



1. Clutch control (lever) and gear change (twist grip) -
2. Front brake lever - 3. Throttle twist grip - 4. Main switch unit -
5. Front brake shoes - 6. Rear brake pedal - 7. Kick-starter -
8. Gear selector - 9. Rear brake shoes - 10. Clutch -
11. Carburettor and air cleaner - 12. Choke control - 13. Fuel cock -
14. Fuel tank cap.

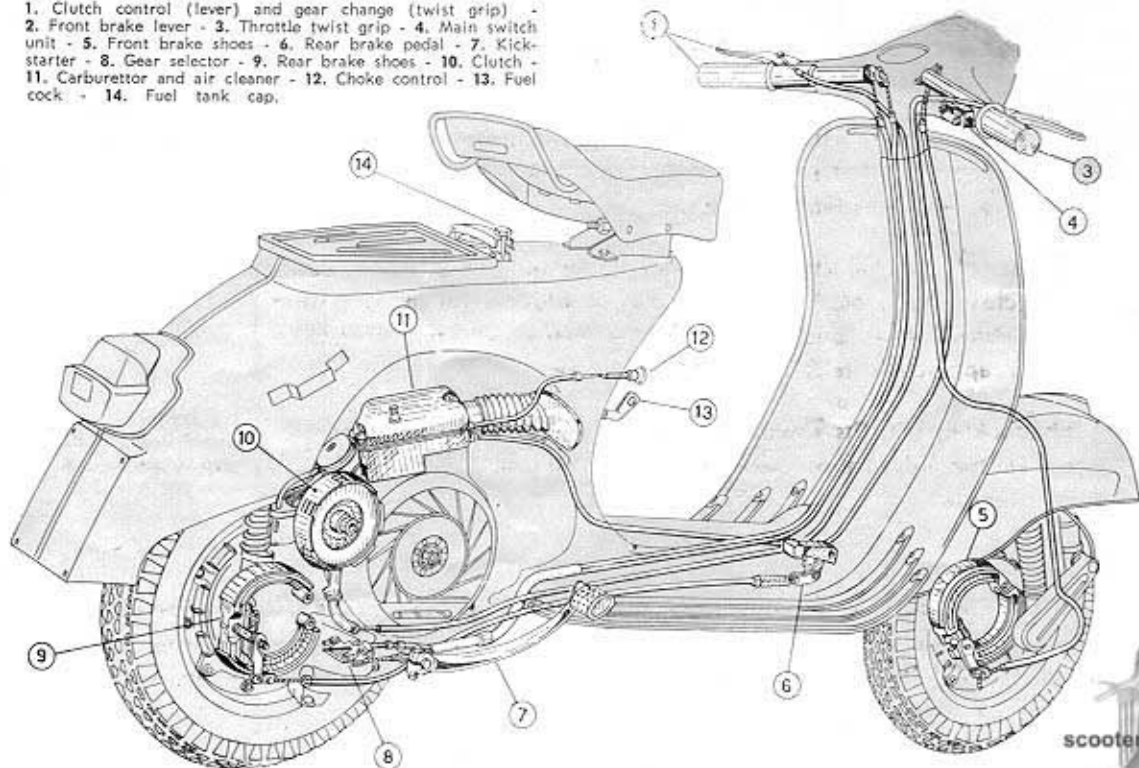

Fig. 2 - Installation of controls and transmissions



OPERATING INSTRUCTIONS

OPERATION	INSTRUCTIONS	NOTES
SECURITY LOCK	The vehicle is provided with two security locks, the one relates to the steering column (locking and unlocking the handlebar) and the other one for locking the tool box. Both operated by a common key.	Both the locks should not be lubricated.
STEERING LOCK a) Locking the handlebars	To lock the vehicle, turn the handlebars anticlockwise up to the limit stop; rotate the key anticlockwise and push inwards , so that it thrusts the sliding bar against the steering column. To ease the insertion of the sliding bar into the hole of the steering column, slightly turn the handlebars from the limit stop clockwise. When the handlebars are locked the key will now spring back to its original position and can then be withdrawn.	The key can be extracted from the lock even if the handlebars are free.



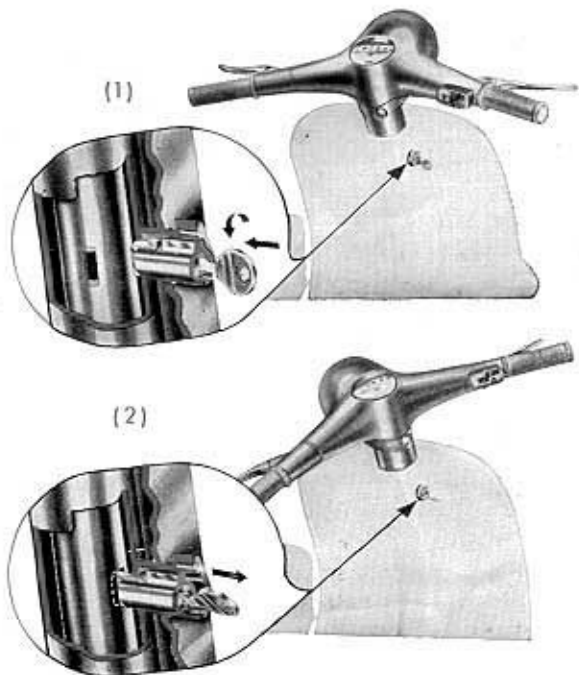

Fig. 3 - Steering lock

1. Normal position - 2. Locked position

Note - The arrows indicate the operation to be carried out for locking (1) and for unlocking (2).

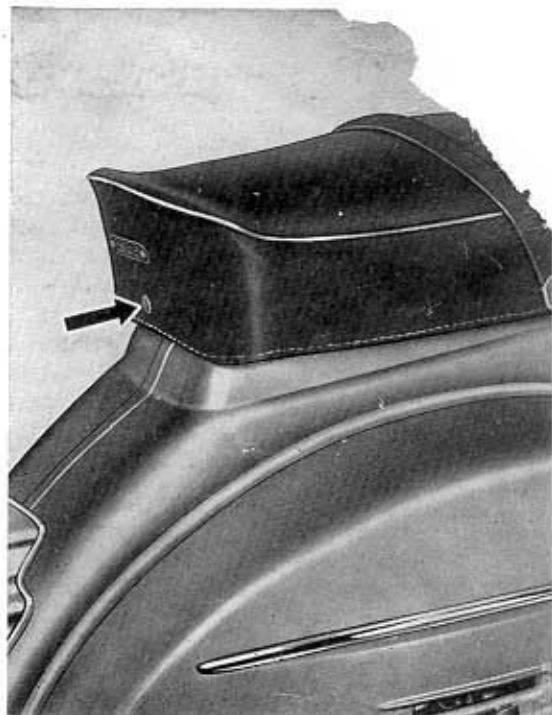

Fig. 4 - Application of dualseat

N. B. - For access to fuel tank push the button indicated by arrow and pivot the seat on its forward edge.

scooterhelp.com



OPERATING INSTRUCTIONS

OPERATION	INSTRUCTIONS	NOTES
b) Unlocking the handlebars	To release the handlebars, insert the key in the lock , turn it to the left and pull it back ; then turn the handlebars in the normal position.	
FUEL SUPPLY	Use a mixture of oil and petrol i. e. 2% Pure Mineral Oil SAE 30 (i. e. about 1/4 pint of oil per 1½ gals of petrol): Esso 2-T Motor Oil; Shell Golden Motor Oil; Shell X-100 2 T. Do not use detergent oils.	Ensure that the fuel tank breather is always clean.
ACCESS TO FUEL TANK	The fuel tank is provided with a hinged plug located under the saddle. For access to fuel tank when the dual seat is fitted, pivot the seat on its forward edge, after having released the rear attachment as shown at fig. 4.	



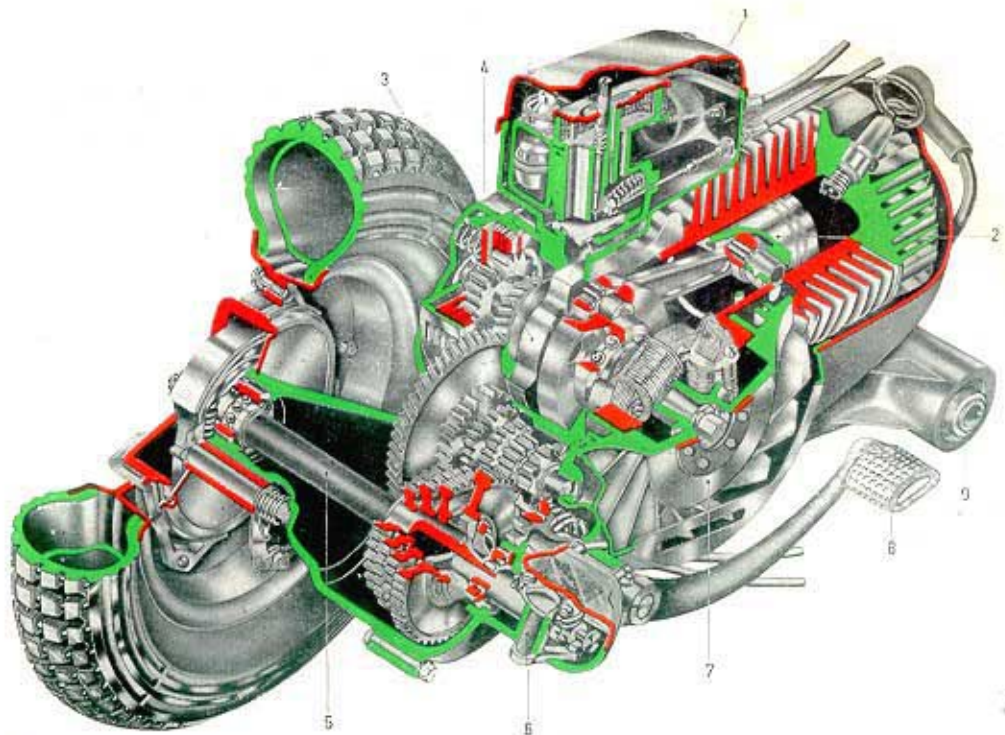

Fig. 5 - Engine section

1. Group carburettor air cleaner - 2. Piston - 3. Crankshaft - 4. Clutch - 5. Mainshaft and gear pinion assy - 6. Gear shifter - 7. Flywheel magneto - 8. Kickstarter - 9. Crankcase swinging arm clutch side (pivoted to the frame).



OPERATING INSTRUCTIONS

OPERATION	INSTRUCTIONS	NOTES
BEFORE OPERATING THE VEHICLE	Unscrew the plug on the gear box marked « OLIO » (second detail, bottom, L. H., fig. 18) and check that the oil is level with the hole when the vehicle is standing upright.	
RUNNING - IN PERIOD	<p>For running - in the first 2000 Km. (1200 mls), do not keep the throttle fully open for long periods.</p> <p>After first 1000 Km. (600 mls) change oil in gear box (see fig. 18) and check that all nuts and bolts are tight.</p> <p>Check that the carburettor is tight on the crankcase to avoid any possibility of air leaks.</p>	
TYRE PRESSURE	Front 1.1 Kg/cm ² (15.5 p.s.i.): Rear 1.3 Kg/cm ² (18.5 p.s.i.) with one up; Rear 2.3 ÷ 2.5 Kg/cm ² (32.7 ÷ 35.5 p.s.i.): with two up.	



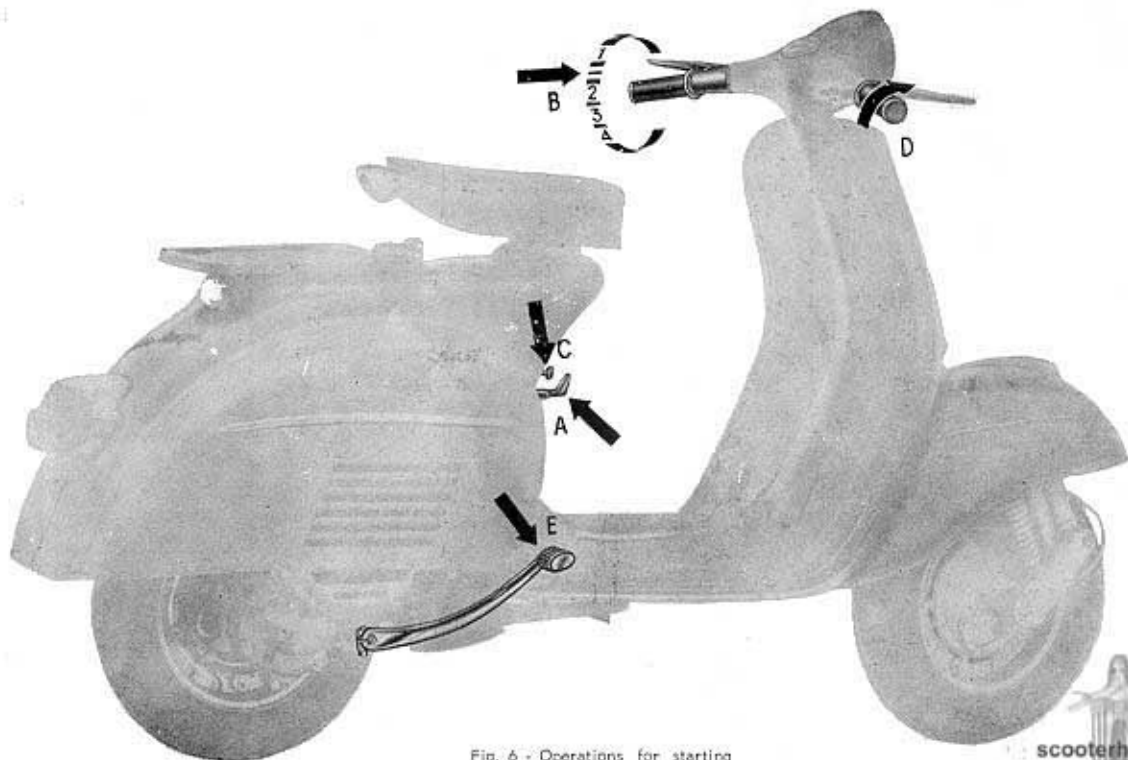

Fig. 6 - Operations for starting

A: Open the fuel tap - **B:** Selector in neutral - **C:** Pull out the choke control (with cold engine) - **D:** Bring throttle twist grip to idling position - **E:** Operate kickstarter.

OPERATING INSTRUCTIONS

OPERATION	INSTRUCTIONS	NOTES
STARTING	— Carry out the operations indicated on fig. 6. Do not use the choke when the engine is warm ; as soon as the engine is running smoothly bring the choke control back to its normal position.	In case of hard starting see page 16.
SETTING THE SCOOTER IN MOTION	— With the engine running at idling speed declutch and rotate the gear change twist grip to the position of first gear (fig. 7). For setting the vehicle in motion slowly let in the clutch and gradually open the throttle.	Do not attempt to ride the vehicle unless the key is inserted and the handlebars rotate freely.
GEAR CHANGE	— Close the throttle, declutch and rotate the gear change grip to a higher or lower gear, as the case may be (fig. 7).	When it is necessary to decelerate do not hesitate in changing down.
STOPPING THE ENGINE	— Before stopping the engine change to « neutral » and then switch off the ignition.	



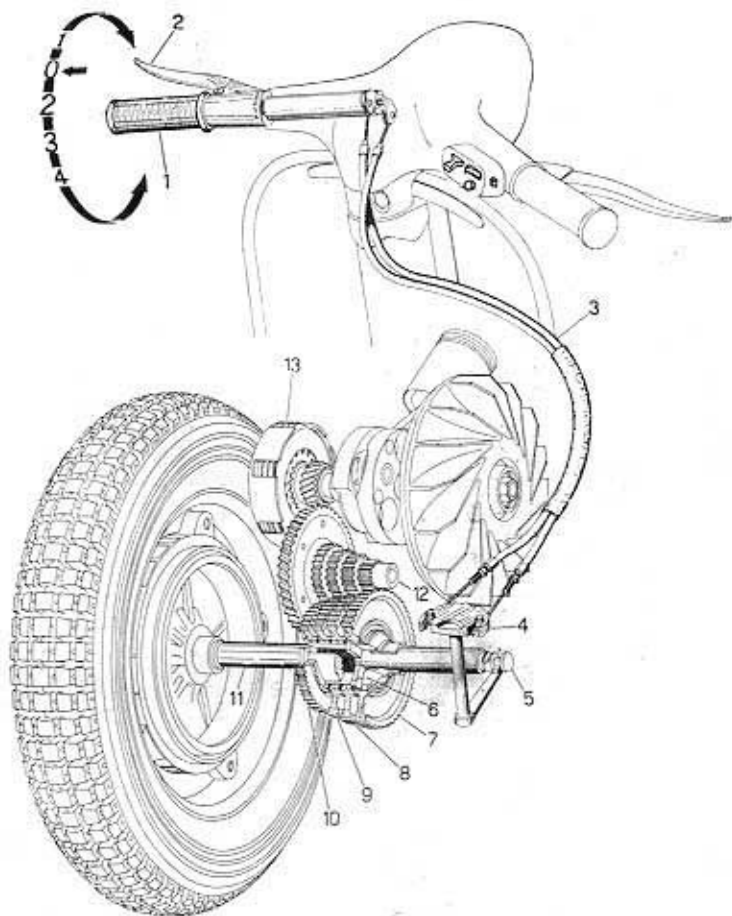

Fig. 7

1. Gear change twist grip - 2. Clutch control lever - 3. Gear change cables - 4. Gear shifter - 5. Selector stem - 6. Selector spider - 7. 1st gear - 8. 2nd gear - 9. 3rd gear - 10. Top gear - 11. Mainshaft - 12. Spring gear - 13. Clutch.

N. B. - The positions 1-2-3-4 on the change twist grip correspond to bottom, 2nd, 3rd and top gear respectively; the «0» indicates neutral.



OPERATING AND MAINTENANCE: COMMON OPERATIONS TO CARRY OUT

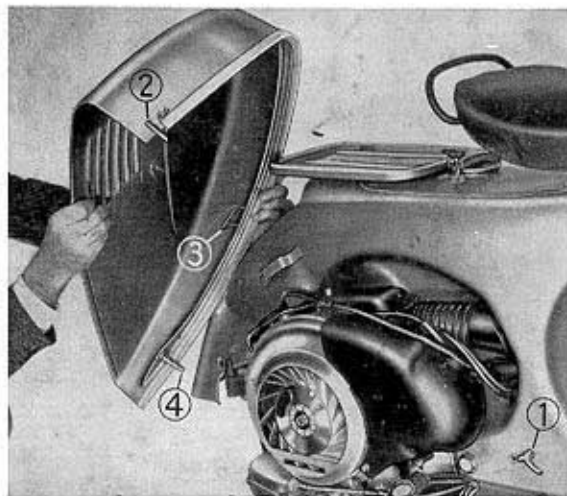

Fig. 8 - Removing engine cowl.

1. Lever for locking cowl. - 2. Front locating pin - 3. Clasp securing cowl. to chassis - 4. Rear hooked pivot pin.

REMOVAL OF ENGINE COWLING

- Pull the lever « 1 » and turn to release from cowling. Swing the cowling outwards so that the front locating pin « 2 » is free of its housing.
- Lift the cowling upwards from the front pivoting on its rear section: so as release the clasp « 3 » from the chassis bracket.
- Pull the cowling outwards on the locating pin « 4 » so as the latter clears its housing, thus releasing the cowling.

For reassembly carry out the reverse procedure.

scooterhelp.com



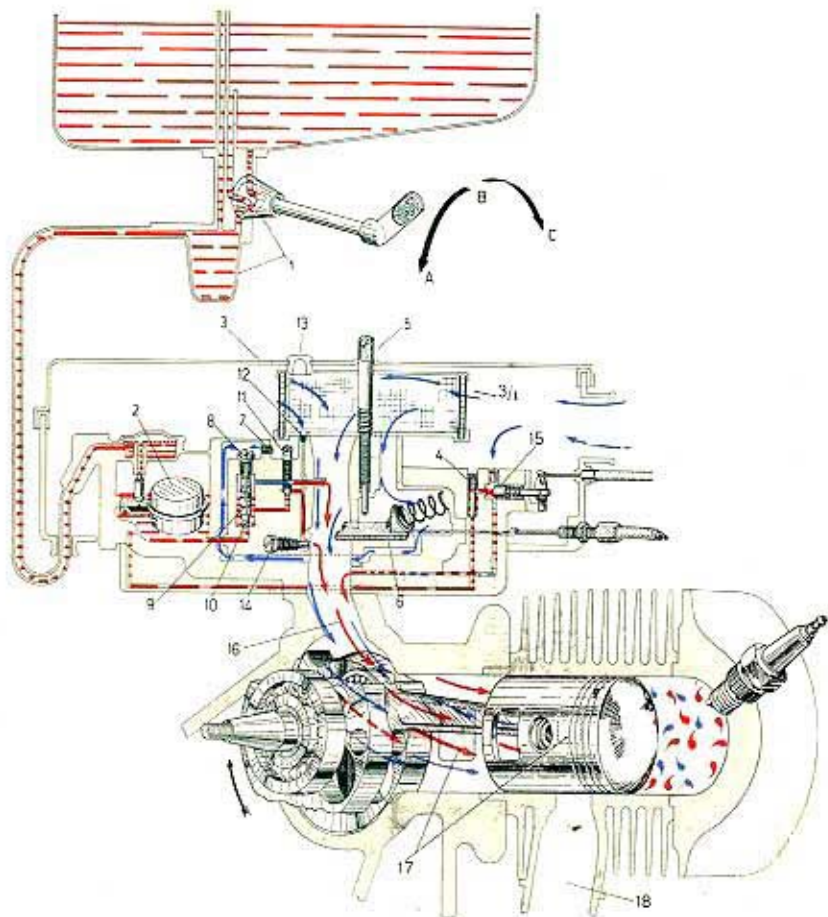

Fig. 9 - Fuel supply and distribution diag.

1. Fuel tap - A) Reserve; B) Open; C) Closed - 2. Float - 3. Carburettor and air cleaner - 3/1. Air filter - 4. Starter jet - 5. Throttle slide set screw - 6. Throttle slide - 7. Main jet air calibrator - 8. Air calibrator on mixer - 9. Mixer - 10. Main jet - 11. Slow running jet - 12. Slow running jet air calibrator - 13. Oil filler plug - 14. Slow running adjuster screw - 15. Starter valve - 16. Inlet port - 17. Transfer - 18. Exhaust port.

OPERATING AND MAINTENANCE: COMMON OPERATIONS TO CARRY OUT

ADJUSTMENTS ON CARBURETTOR

For adjusting the idling turn the slow running adjuster screw (fig. 9 n. 5).

- On the carburettor body a set screw is provided for adjusting the throttle cable play; this screw is to be reset **only if necessary** or on dismantling and reassembly operations.
- On the air cleaner case, opposite to said screw, is a plugged hole. When this plug is removed the spring loaded idler adjusting screw is accessible (Fig. 9, n. 14).

To avoid carburation troubles we recommend that this adjustment is carried out by a Vespa dealer.

STARTING UP when the engine is flooded:

In the case of difficulties caused by flooding (presence of unvaporised mixture in the cylinder), the following methods can be used:

- Attempt push starting: engage the 2nd gear, declutch, push the vehicle to a certain speed, sharply release the clutch and when the engine fires declutch immediately.
- Close the fuel tap, remove the sparking plug (fig. 10) and clean; then kick over the engine several times.
- Screw in the sparking plug secure, open the fuel tap and start the engine.



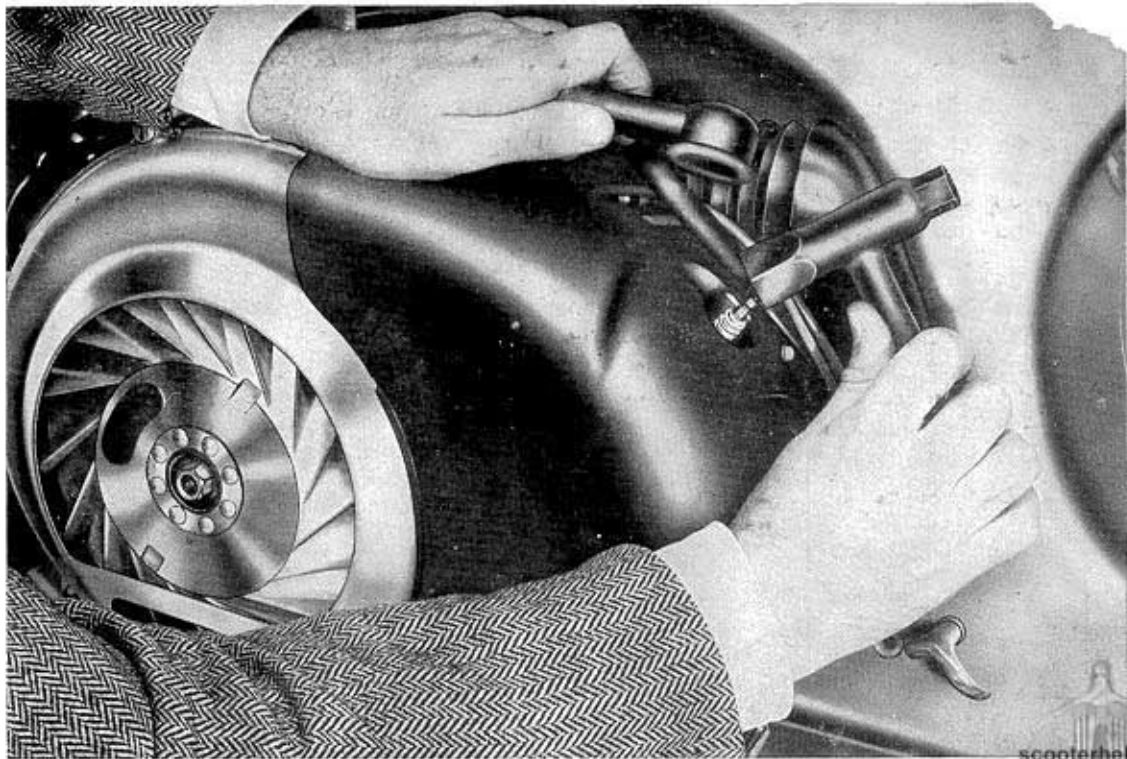

Fig. 10 - Dismantling spark - plug



OPERATING AND MAINTENANCE: COMMON OPERATIONS TO CARRY OUT

OPERATION	INSTRUCTIONS	NOTES
SPARKPLUG REMOVAL	<ul style="list-style-type: none"> — Remove engine cowl (Fig. 8), disconnect the H. T. lead and extract the spark-plug using the box wrench as indicated in fig. 10. 	<p>On reassembling the spark-plug ensure that it is entered into the threaded hole at the correct angle.</p>
CHANGING OIL IN GEAR BOX	<ul style="list-style-type: none"> — Drain off through hole fig. 18, 2nd detail, letter « S »). — Introduce a small quantity of flushing oil, run the engine a few minutes to ensure thorough circulation and cleaning and drain off again. — Refill gear box with about 250 grs. of new oil (up to level of filling hole). 	<p>This operation of changing oil should be carried out with warm engine.</p>
DISMANTLING AIR FILTER	<ul style="list-style-type: none"> — For extracting the air filter « A » (fig. 11) from the air filter case remove the engine cowl (fig. 8) and air cleaner case cap. Unscrew the two screws « B » securing the air filter and extract the latter component. 	<p>The air cleaner case cap can be extracted by dismantling the two securing screws.</p>



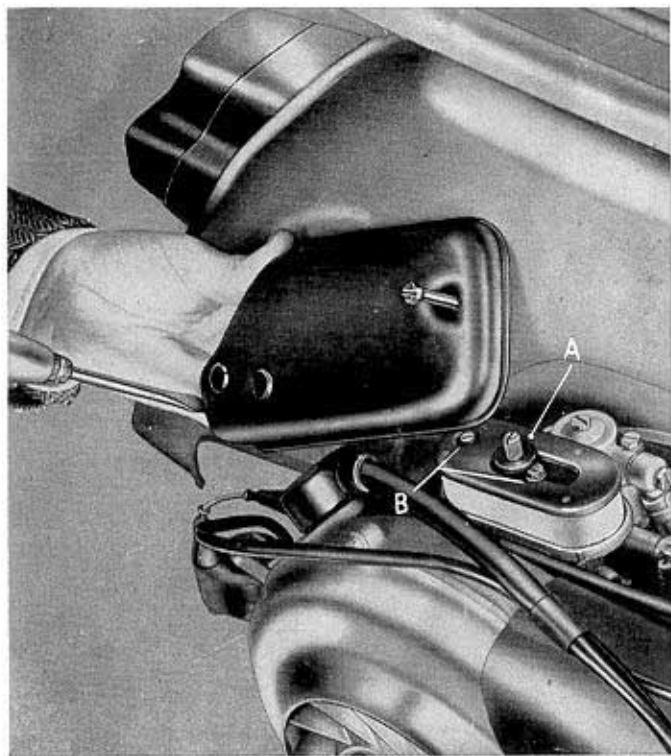

Fig. 11 - Dismantling the air cleaner.

Note - To reach the carburettor, remove the air cleaner case.

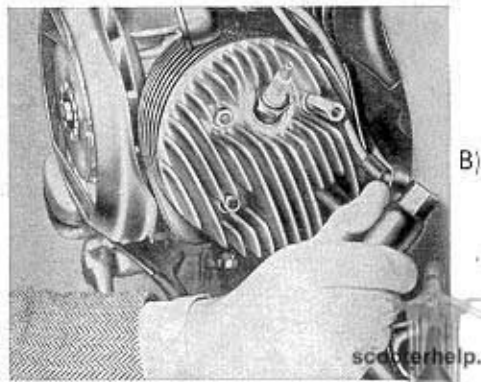
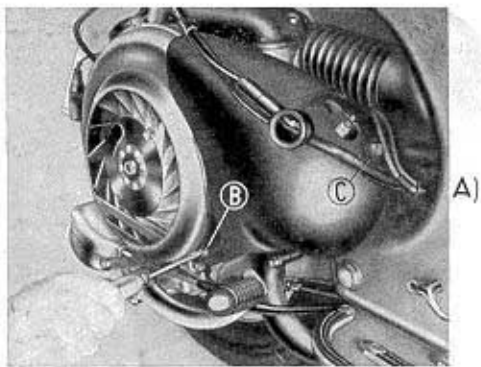

Fig. 12 - Dismantling cooling hood from engine (A) and head (B).

OPERATING AND MAINTENANCE : COMMON OPERATIONS TO CARRY OUT

OPERATION	INSTRUCTIONS	NOTES
DISMANTLING CYLINDER HEAD	<p>— Strip off engine cowling, (Fig. 8), disconnect the H.T. lead, dismantle the « Cooling hood » (fastenings « B » - « C », fig. 11) and unscrew the 4 securing bolts by means of a box wrench.</p>	
CHANGING WHEELS AND TYRES	<p>— For dismantling the wheels from the vehicle remove the bolts as indicated in fig. 13. On reassembly tighten said nuts alternately and progressively.</p> <p>— When a tyre has to be removed, first deflate and then remove the nuts joining the two wheel rims (Fig. 17).</p>	<p>The front and rear wheel are interchangeable one with another providing that the tyre pressures are regulated accordingly (page 10).</p>
BRAKE ADJUSTMENT	<p>— Rotate the adjusting screws indicated in fig. 14, so that the wheel is completely free to rotate when the lever and brake pedal are in the resting position.</p>	<p>The braking action should commence immediately the respective controls are operated.</p>



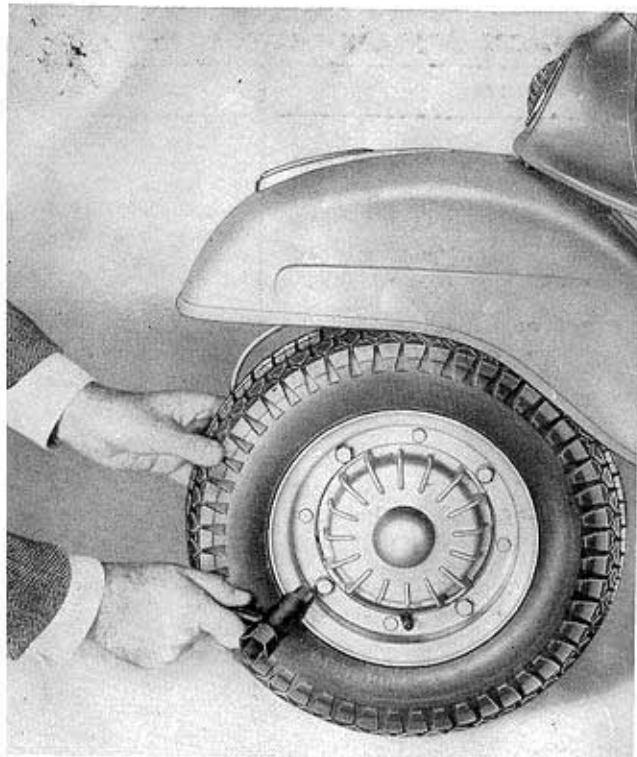

Fig. 13 - Removing wheel from vehicle

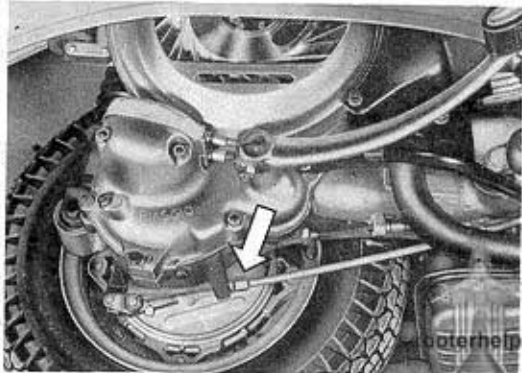
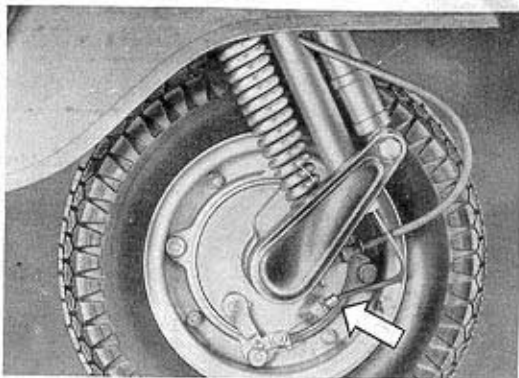

Fig. 14 - Brake adjustment

OPERATING AND MAINTENANCE : COMMON OPERATIONS TO CARRY OUT

OPERATION	INSTRUCTIONS	NOTES
CHECKING AND SETTING THE FLYWHEEL MAGNETIC TIMING	<ol style="list-style-type: none"> 1) Selector in neutral, take off the rubber plug located on the rotor and rotate it by hand until the contact breaker unit (fig. 15) is seen through the hole of the flywheel rotor. 2) At the position indicate in the figure the contact breaker points « A » should start to open, i. e. when the extremity of the coil is at a distance of 2 ÷ 4 mm. (0.078" ÷ 0.15") from the respective pole shoe. 3) By rotating again the rotor by hand, the max. opening should be between the limits 0.3 to 0.5 mm. (0.011" to 0.019"). 4) If the conditions as per points 2) - 3) are not obtained, rotate the screw « B » and rotate the cam « C » until fo-resaid conditions are obtained. 	<p>In order not to disturb ignition timing, do not slacken the stator plate or coil securing screws.</p> <p>If necessary to adjust the spark advance, consult the Service Station.</p> <p>Ensure screw « B » is tightened after having finished the operation.</p>



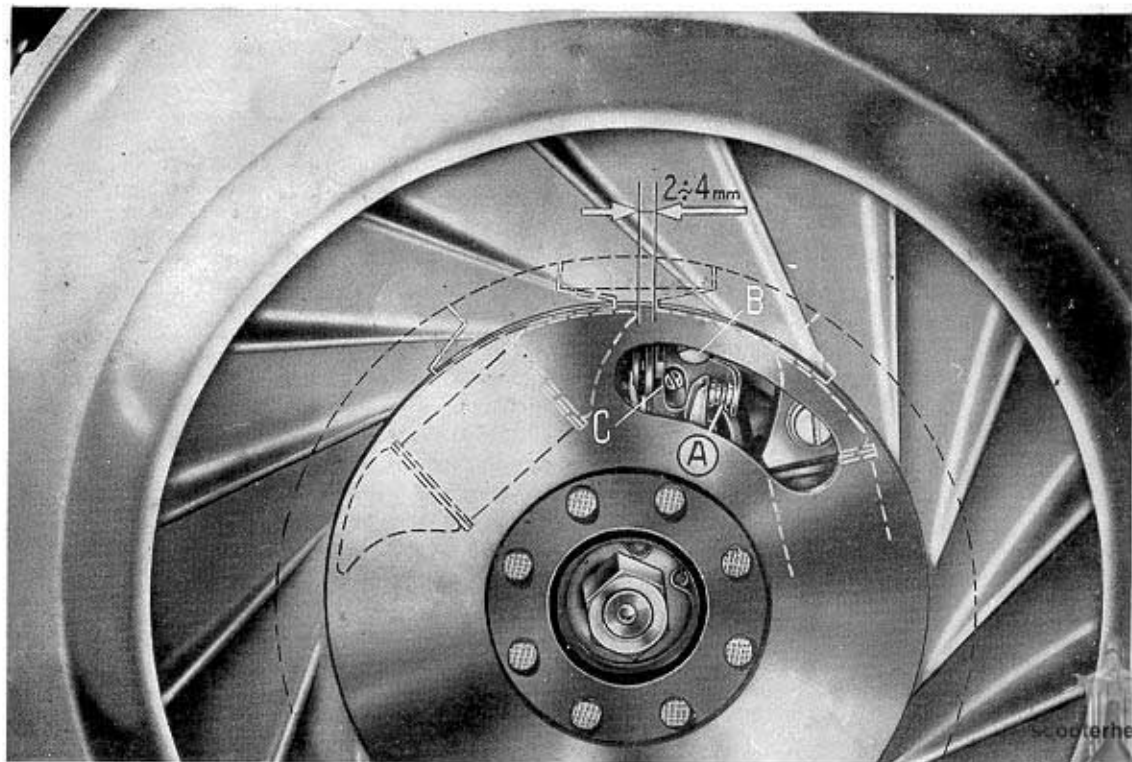

Fig. 15 - Operations for checking the «magnetic» timing of the flywheel

OPERATING AND MAINTENANCE : COMMON OPERATIONS TO CARRY OUT

OPERATION	INSTRUCTIONS	NOTES
<p>REPLACING BULBS</p> <p>SETTING THE HEADLAMP</p>	<p>Should one of the headlamp bulbs fail, before fitting a replacement, check the rear light bulb for serviceability and vice versa.</p> <p>The correct setting of the main beam can be obtained both horizontally and vertically as follows:</p> <p>Check that both front and rear tyres are inflated to correct pressures; i. e. 1.1 and 2.5 Kg/cm² (15.5 and 35.5 p.s.i.). Place the scooter on a level floor in front of a white wall as seen in Fig. 16. Start the engine hold the throttle control twist grip at about 1/3 and set the switch on « main beam ». With two persons on the Vespa, slacken the screw securing the headlamp, then move the latter as required, in order that the beam axis coincides with point « 0 » on the wall. Tighten the screw firmly.</p>	<p>Before switching on the new light bulbs check (on assy.), that the socket contact points are efficient.</p> <p>Do not wipe down with a cloth or contact with finger the reflector.</p> <p>This operation can be carried out also with the driver only sitting on the machine. In this case, of course, the beam alignment should be altered whenever the scooter is being ridden by both driver and passenger.</p>



SETTING THE HEADLAMP

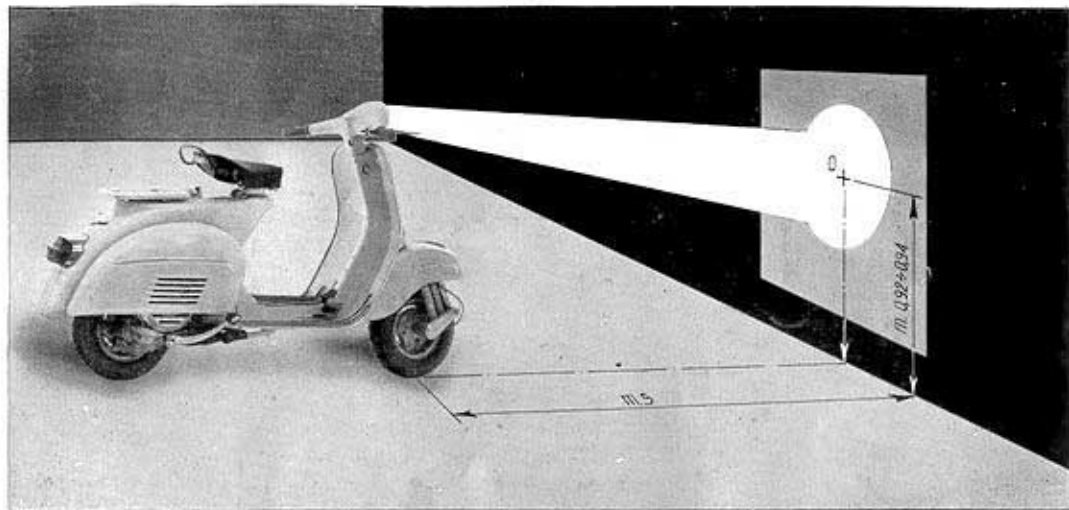

Fig. 16 - Setting the headlamp.

N. B. - The point «0» is valid for setting with one or two persons mounted.

Note: m. 5 = 16 FT approx.; m. 0,92 - 0,94 = 3 FT approx.



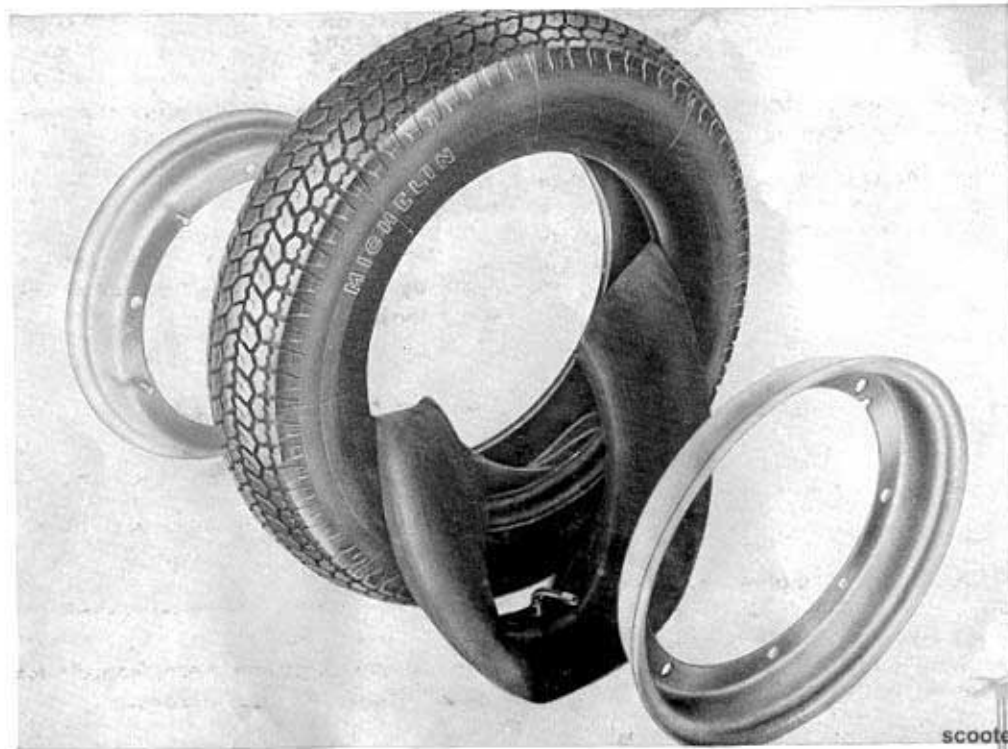

Fig. 17 - Tyre removal



MAINTENANCE

When difficulties of starting or running occur, check the spark plug:

— Clean the spark plug electrodes with a wire brush or emery cloth and adjust the gap 0,6 mm. (0".023). Check porcelain insulation: if cracked or broken change the plug.

Clean in neat petrol.

It is advisable not to change the type of spark plug prescribed by factory.

Every 4000 Km (2400 mls):

1) - Check oil level in gear box.

2) - De-coke the engine (cylinder head, piston crown and cylinder ports). Ensure that not residual carbon deposits remain inside the cylinder. Clean the exhaust pipe using a hooked steel wire.

3) - Grease front hub through the appropriate nipples and lubricate the speedometer drive and transmission, the brake lever and gear selector.

4) - Remove the air filter, (see page 18), clean by agitating in an oil petrol bath and if possible air blast dry.

Every 8000 Km (4800 mls):

1) - Change oil in gear box (see pag. 18).

2) - Grease control cables and lubricate the felt lubricating pad on flywheel.

3) - Clean, and if necessary, reset the contact breaker points (fig. 15). To avoid faulty ignition or other defects, **consult your Service - Station for this operation.**



SUMMARY OF INSTRUCTIONS FOR MAINTENANCE AND LUBRICATION

PRINCIPAL OPERATIONS TO CARRY OUT		Lubricants	Notes
4000 Km. (2400 mls)	Every 8000 Km. (4800 mls)		
<p>Gear box (top up)</p> <p>Fulcrum points of brake lever and pedal</p> <p>Speedo drive and transmission</p> <p>Gear selector</p> <p>Front suspension</p> <p>Cleaning air filter (in petrol)</p> <p>Decoking silencer</p> <p>Decoking cylinder head and piston *</p> <p>Cleaning and adjusting spark plug electrodes</p>	<p>Gear box (Change oil)</p> <p>Greasing control cables *</p> <p>Felt lubric. pad on flywheel *</p> <p>Cleaning and adjusting contact breaker points (check timing *)</p>	<p>Oil SAE 30,</p> <p>{ Esso Beacon 3, Mobilgrease MP Shell Retinax A</p>	<p>* Consult your Service Station.</p> <p>(*) e. g. : Esso 2-T Motor Oil; Shell Golden Motor Oil; Shell X-100 2-T.</p>
<p>Engine: At each refilling (lubricated by oil in fuel),</p>		<p>2% by volume Pure mineral oil SAE 30 (*).</p>	
<p>Front and rear dampers (only if defective *)</p>		<p>Esso Unisvis J 43; Shell Tellus Oil 13; Mobilfluid 62.</p>	



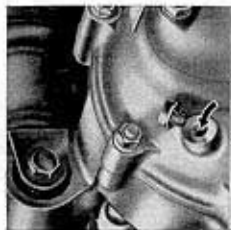

OIL SAE 30

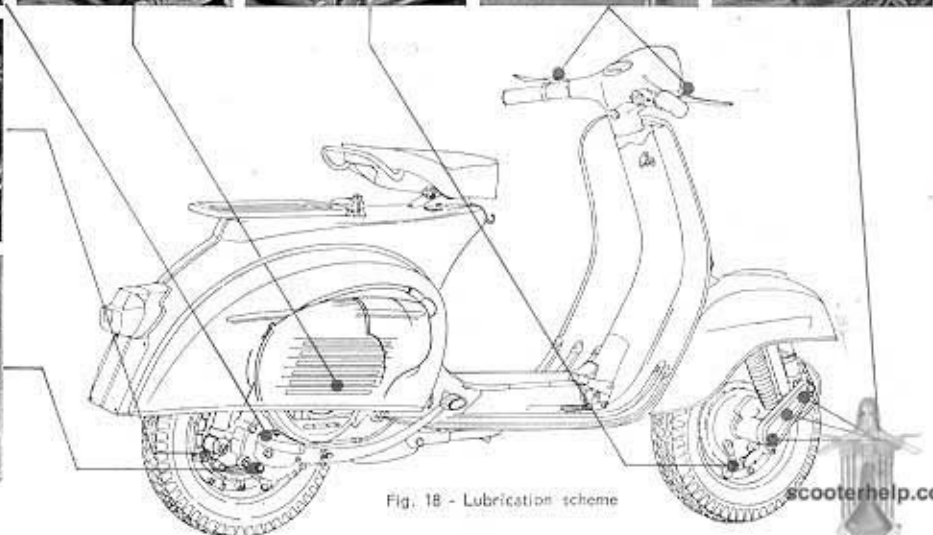

Fig. 18 - Lubrication scheme

scooterhelp.com

Notice - 2nd detail, L, H.; « S » indicates the oil draining hole from engine.



LAYING UP

We recommend that the following operations be carried out:

- 1) - Clean down the vehicle.
- 2) - With the engine stationary and throttle fully opened, introduce 40 cc. of **OIL SAE 30** through the appropriate hole on the air cleaner case (n. 13, fig. 9). After said operation depress the kickstarter three or four times.
- 3) - Drain off all fuel contained in the fuel tank; then grease over all unpainted metallic parts; next raise the wheel off the ground by placing wooden chocks under the footrest.

CLEANING THE VEHICLE

Notice :

Washing and polishing operations should not be carried out in the sun, particularly during the summer when the bodywork is warm.

Under no circumstances should petrol or Diesel oil be used for washing painted surfaces or plastic material as they will deteriorate.

Always wash the scooter before polishing.

1) **Engine.**

For cleaning the exposed surface of the engine use paraffin, a brush and clean rag.

scooterhelp.com



2) Bodywork.

— Washing.

Painted parts should be washed down using a low pressure hose. Do not use a high pressure system as grit may be forced into the paint.

When the dirt and grime becomes soft, sponge off using one of the « car type » shampoos available (use a product of the type Rolene and Teepol, which are employed in aqueous solution, 3 ÷ 5% by weight). First, lightly wash the painted surface of the scooter, in order to avoid scratching. Thoroughly rinse with plenty of water. Dry off using a clean chamois leather to eliminate water marks.

— Spots.

To remove spots caused by tar, grease, insects, etc., rub gently with a soft cloth dipped in oil or turpentine. More persistent marks can be removed with a solution of warm water and car shampoo.

Carry out this procedure periodically, to eliminate permanent paintwork damage.

— Polishing.

If after washing, as previously described, the original condition is not restored, apply evenly a thin coat of good quality wax polish and shine with a soft cloth, rubbing gently in a side to side manner.



FAULT FINDING

When the machine does not run properly, inspect and rectify as explained below.

If the suggested remedies are not sufficient in eliminating the trouble, consult your Dealer.

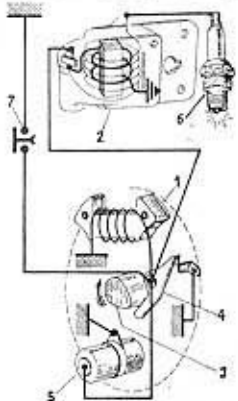
Fault finding	Remedies	Notes
<p>HARD STARTING</p> <p>1. - Fuel system - Carburation - Ignition.</p> <p>Lack of fuel.</p> <p>Filter, jets, fuel tap, carburettor body clogged or dirty.</p> <p>Engine flooding.</p> <p>Air cleaner choked or dirty.</p> <p>Sparkling plug dirty - Porcelain of sparking plug cracked.</p> <p>Breaker points dirty, worn or pitted; gap between point incorrect.</p>	<p>Turn to Reserve and refill as soon as possible.</p> <p>Remove, wash in petrol and blow dry.</p> <p>See page 16.</p> <p>See page 18.</p> <p>Disconnect the plug lead. Check if sparking occurs between lead and crankcase when the kickstarter is operated.</p> <p>Consult your Dealer.</p>	<p style="text-align: center;">Notes</p>  <p style="text-align: center;">Fig. 19 Ignition circuit.</p> <p>1, Flywheel coil - 2, H. T. coil 3, Flywheel cam - 4, Contact breaker - 5, Condenser - 6, Sparking plug - 7, Engine cut-off switch</p>



Fault finding	Remedies	Notes
<p>VARIOUS RUNNING DEFECTS</p> <p>1. - Lack of power - High fuel consumption.</p> <p>Spark plug misfiring (see fig. 19).</p> <p>Silencer (or engine) choked.</p> <p>Spark plug loose in the cyl. head.</p> <p>Cylinder head loose.</p> <p>Air filter choked or dirty or choke control incorrectly set.</p> <p>2. - Defective electrical equipment.</p> <p>Wire terminals disconnected or carelessly connected.</p> <p>Headlight beam incorrectly set.</p> <p>Defective bulbs.</p>	<p>Clean or substitute. Clean the contact breaker - Check the electrode gap of the sparking plug; check the flywheel timing (see page 22).</p> <p>Clean (see page 27).</p> <p>Screw down with a wrench.</p> <p>Set head accurately and tighten nuts.</p> <p>Wash in neat petrol, air blast dry. Check choke control mechanism.</p> <p>Carefully check and connect.</p> <p>Adjust (see page 24).</p> <p>See page 24 for substituting.</p>	<p>Notice: When the carburettor is defective, the engine lacks in compression, noisy engine, defective suspension and brakes, general mechanical failures, consult your Dealer.</p> <p>When overhauling the front suspension, grease the wheel bearings with FIAT JOTA 3 or SHELL ALVANIA 3 (or SHELL RETINAX A).</p>



GENERAL SPECIFICATION

Engine (see fig. 5): Single horizontal cylinder two stroke rotary distribution: i. e., carburated mixture is regulated by the crankshaft rotation. Performance and specifications concerning Vespa 150 cc. and 125 cc. at pages 42 - 43.

The engine is pivoted to the vehicle's chassis through the crankcase swinging arm, clutch side (fig. 20). The rear wheel is fitted on the outer side of the drive shaft.

Lubrication of engine components (piston, cylinder, crankshaft, main bearing) is effected by the oil in the fuel mixture. The clutch and gear box function in oil bath.

Fuel supply (see fig. 9): gravity feed with mixture of oil and petrol.
3 way tap: « closed », « open », « reserve ». Carburettor located in the air filter housing, provided with a throttle slide.

Ignition by means of a H. T. flywheel magneto external coil.

Clutch (see fig. 5): multiplate on the crankshaft. The unit is operated by a lever located on L. H. handlebars and adjustable cable.

Gear box (see fig. 7): four speed drive with mesh gears. Operated by the twist grip on L. H. handlebar which functions in conjunction with the **clutch** control lever.

Transmission ratio engine to driving wheels see at pages 42 - 43.

Starting (see fig. 6): by means of a kick-starter on the R. H. side of the vehicle.

Cooling: by means of a centrifugal fan.

Air intake: located inside the frame.

Muffler: expansion and absorption type.

Integral châssis (fig. 1): pressed sheet steel, streamlined monocoque type structure.

Handlebars: Light alloy casting comprising **speedometer**. All transmission cables and various controls are concealed therein

scooterhelp.com



1. Steering column and front suspension.
2. Engine
3. Crankcase clutch side with swinging arm pivoted to frame
4. Rear suspension spring and hydraulic damper assy.

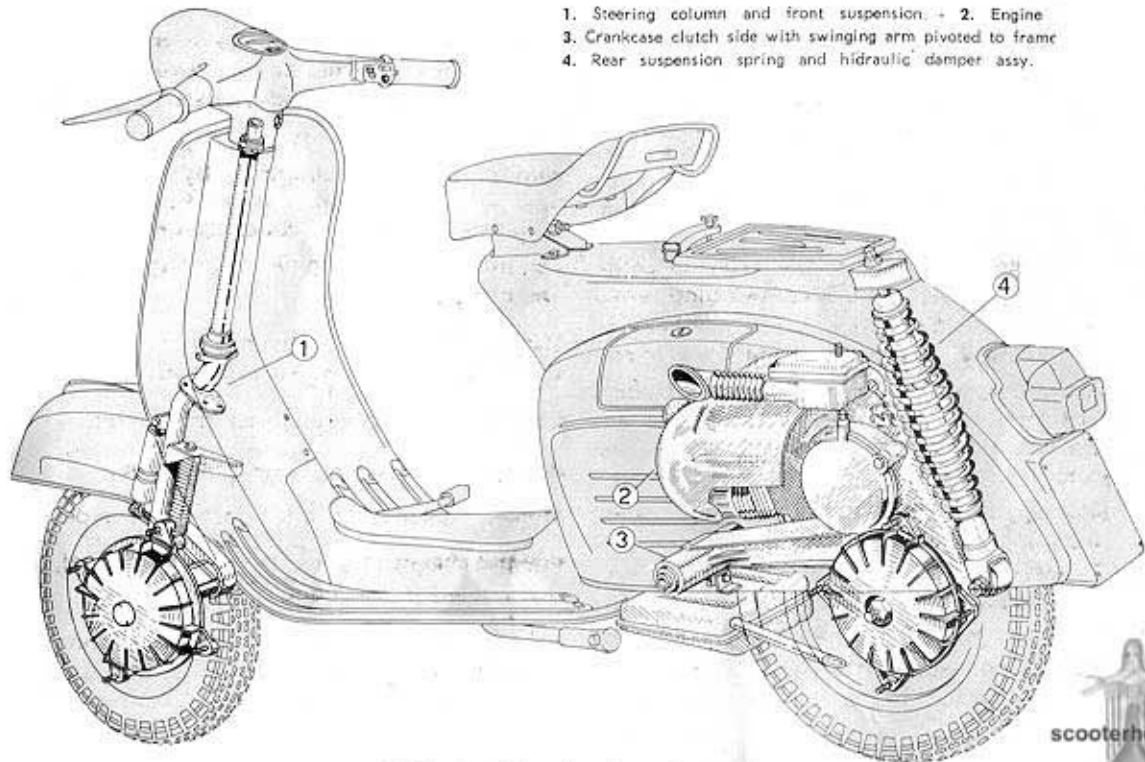

Fig. 20 - Installation of engine and suspension



Steering column, suspension : On the lower end of the steering column is pivoted the front wheel swinging hub. Front and rear suspensions with helical spring and double acting hydraulic damper.

Wheels: Intercangeable and made up of pressed steel flanges; 3,50-8" tyres.

Saddle: single saddle or dual saddle (optionally instead of single and luggage rack).

Brakes: cable operated expanding type. Front brake is operated by hand-lever (R. H. handlebars); the rear brake is pedal operated on R. H. footboard.

Parking stand: a two legged stand with a central return spring.

Steering lock: with a sliding bar acting on the steering column.

STANDARD TOOL KIT

1 four ended box wrench (11 - 14 - 21 - 22 mm.); two double open - ended wrenches (11 - 14 and 7 - 10 mm.); one single open -

ended wrench (8 mm.). One **screwdriver**. These tools are contained in a canvas roll together with this booklet which is placed in the tool box, left side of vehicle.

ACCESSORIES

On request the vehicle can be furnished with the following accessories:

Dual saddle of a special long shape suitable for two persons (driver and passenger), provided with a hand grips for passenger.

Rear passenger saddle can be secured on the frame instead of the luggage rack, the central spring can be adjusted to the passengers weight. In place of it can be supplied: a **foam rubber pillion seat** to be applied over the luggage rack, the latter being issued as standard equipment.

Spare wheel and bracket which can be secured to the frame.

Windscreen: extremely easy to be secured on the handlebars.

scooterhelp.com



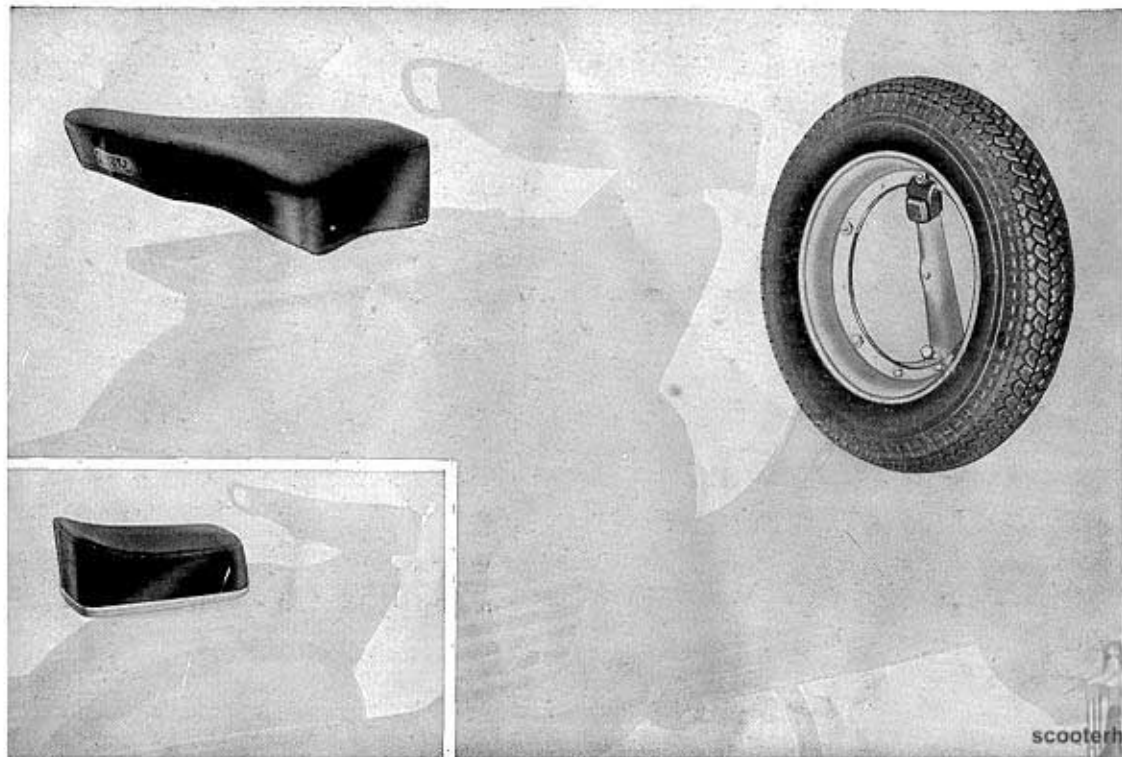

scooterhelp.com

Fig. 21 - Application of accessories: passenger saddle (after having removed the luggage rack), pillion seat, spare wheel



ELECTRICAL EQUIPMENT

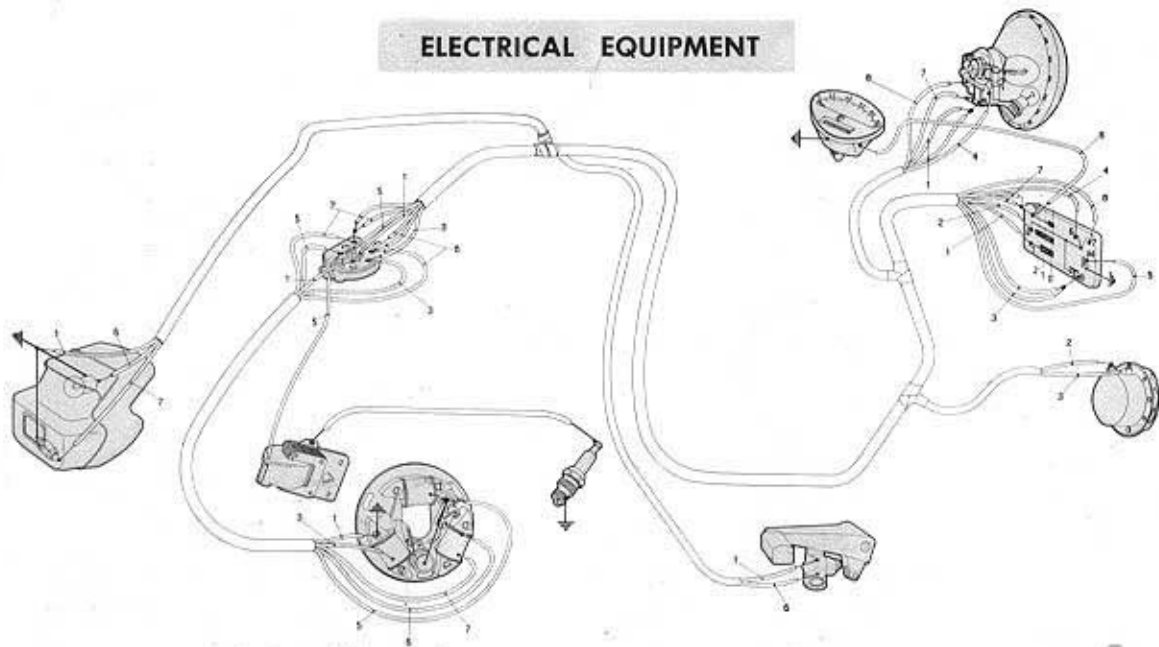

1. Black - 2. White - 3. Green - 4. Brown - 5. Red - 6. Blue - 7. Yellow - 8. Violet.

The electrical equipment is fed by alternating current, nominal voltage 6 V. This equipment consists of the following lighting and signalling devices: The headlamp, diameter 115 mm., 6 V - 25/25 W bulb (main and dipped beam); front pilot light and light for registration plate 6V - 5 W; Speedometer light 6 V - 0,6 W, Stop light 6 V - 10 W; Horn 6 V a. c.. The flywheel is provided with 6 poles.



ELECTRICAL EQUIPMENT

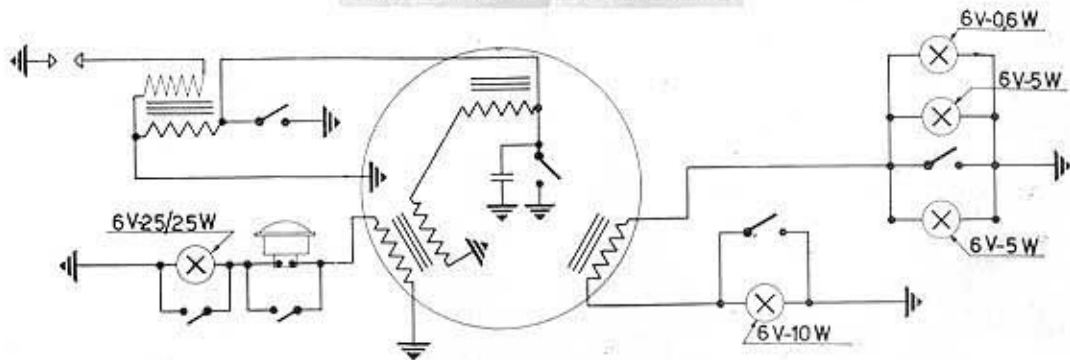

Fig. 22 - 23 - Installation of electrical equipment - see Fig. at page 38 and electrical connections - see Fig. at the present page.

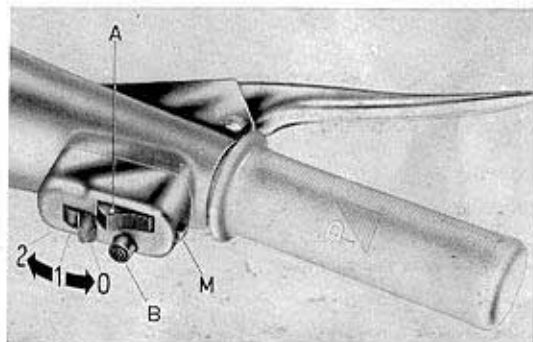

Fig. 24 - Light and dip switch

0 - 1 - 2: Switching lever positions. - 0, Lights off.
 1. Pilot light and tail lamp on. - 2. Head light and tail lamp on - A: Main and dipped beam switch - B: Horn button - M: Engine cut-out.



IDENTIFICATION DATA

They consist of a prefix VBC 1 for Vespa « Super 150 » and VNC 1 for Vespa « Super 125 » and progressive number.

The chassis prefix and serial number, stamped on the frame and engine, identify the vehicle as prescribed by law, are always carried out on the documents pertaining to the vehicle: **these numbers should be quoted when ordering spare parts.**

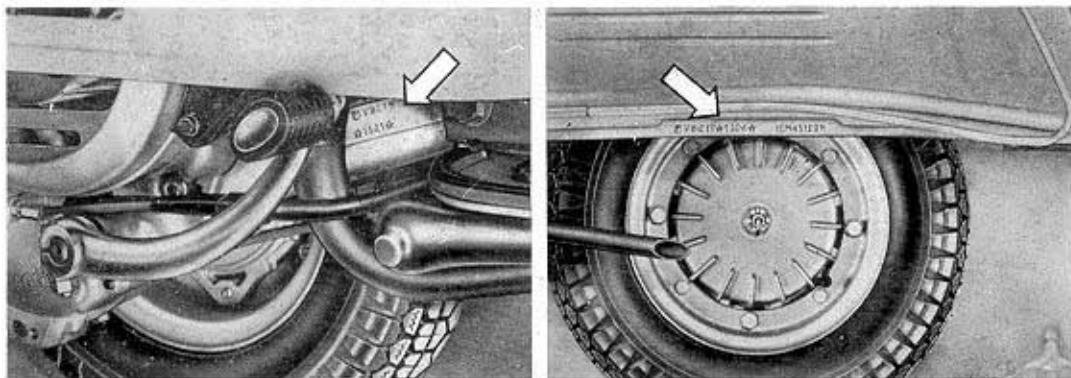

Fig. 25 - Serial number stamped on frame and on engine.



SPECIFIC CHARACTERISTICS
OF THE VESPA SUPER



Vespa « Super 150»: PERFORMANCE AND SPECIFICATIONS

Consumption (accord to CUNA Standard):
2.2 lt/100 Km. (107.5 mls/U.S. gal.;
129.2 mls/imp. gal.), **gasoline - oil mixture i. e. 2% oil.**

Max speed (CUNA Standards) 90 Km/h
(55.92 mph.).

Carrying capacity 2 persons
and 10 Kg. (22 lbs) of luggage.

Range 350 Km (217.5 mls)

Max fuel capacity: 7.7 lt. (2.0 U.S. galls
or 1.7 imp. galls (incl. 1.4 lt. - 0.37 U.S.
galls or 0.31 imp. galls - of **reserve**).

Wheel base 1200 mm (47".24)

Handlebar width 670 mm (26".38)

Total length 1740 mm (68".50)

Max height 1015 mm (39".96)

Min. ground clearance 130 mm (5".12)

Turning radius 1500 mm (59".05)

Total dry weight 87 Kg. (191.8 lbs)

ENGINE: two stroke rotary distribution; i. e., carbureted mixture is regulated by the crankshaft rotation.

Displacement 145.45 cc. - 8,87 cu. in.

Bore 57 mm - 2".24.

Stroke 57 mm - 2".24.

Compression ratio: 1:7.4.

H. T. flywheel magneto external coil **ignition.**

Spark advance: 22° ± 1° before T. D. C.

Sparking plug: Bosch W 225 T 1; Champion L 86; AC 43 F; Marelli CW 230 A - T or CW 225 N - T; KLG F 70 or F 75.

Transmission ratio engine to driving wheels:

Bottom gear 1 : 13.35

2nd gear 1 : 9.32

3rd gear 1 : 6.64

4th gear 1 : 4.73



Vešpa « Super 125»: PERFORMANCE AND SPECIFICATIONS

Consumption (accord to CUNA Standard):
2.1 lt/100 Km. (112.6 mls/U.S. gal.;
135.3 mls/imp. gal.), **gasoline - oil mixture i. e. 2% oil.**

Max. speed (CUNA Standards) 85 Km/h
52.8 mph.).

Carrying capacity 2 persons
and 10 Kg. (22 lbs) of luggage.

Range 370 Km (229,9 mls)

Max fuel capacity: 7,7 lt. (2.0 U. S. galls or
1.7 imp. galls (incl. 1.4 lt. - 0.37 U. S.
galls or 0.31 imp. galls - of **reserve**).

Wheel base 1200 mm (47".24)

Handlebar width 670 mm (26".38)

Total length 1740 mm (68".50)

Max height 1015 mm (39".96)

Min. ground clearance 130 mm (5".12)

Turning radius 1500 mm (59".05)

Total dry weight 87 Kg. (191.8 lbs).

ENGINE: two stroke rotary distribution: i.
e., carbureted mixture is regulated by the
crankshaft rotation.

Displacement 123.4 cc. - 7.53 cu. in.

Bore 52.5 mm - 2".07.

Stroke 57 mm - 2".24.

Compression ratio 1:7.7.

H. T. flywheel magneto external coil **ignition.**

Spark advance: 21° ± 1° before T. D. C.

Sparking plug: Bosch W 225 T 1; Cham-
pion L 86; AC 43 F; Marelli CW 230 A - T
or CW 225 N - T; KLG F 70 or 75.

Transmission ratio engine to driving wheels:

Bottom gear 1 : 13.35

2nd gear 1 : 9.32

3rd gear 1 : 6.64

4th gear 1 : 4.73



STABILIMENTO DI PONTEDERA

UFFICIO TECNICO SERIE

DIS. N. 91954

2.a EDIZIONE, 5000/6605

The descriptions and illustrations in this booklet are not to be taken as binding on the Manufacturer. The essential features of the model described and illustrated herein remaining unaltered, the PIAGGIO Firm reserves therefore the right to carry out at any moment, without being obliged to bring this booklet up-to-date in due course, modification that may occur concerning machine units and parts, or delivery of accessories, that the Firm deems to be convenient on improvement purposes of for what may concern manufacturing or commercial requirements.

Printed in Italy

scooterhelp.com



VBC 1 - VNC 1 - Dis. 91934 - 1^a Ed.

Tip. MCM



scooterhelp.com